

# Structure of Matter

Dr Mohammad Abdur Rashid



# Classification of solids

Solids are broadly classified into two types crystalline solids and amorphous solids.

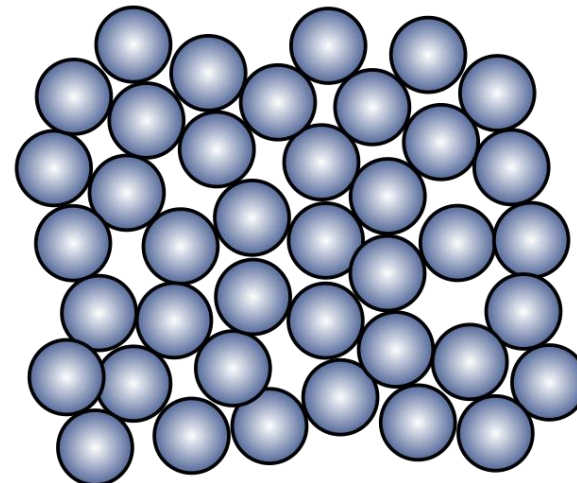
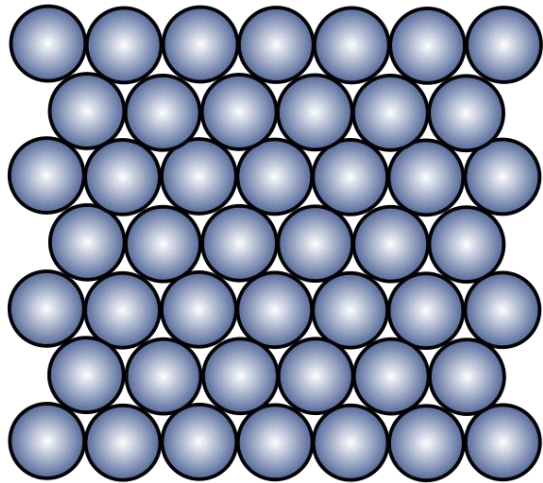

# 2D Crystal

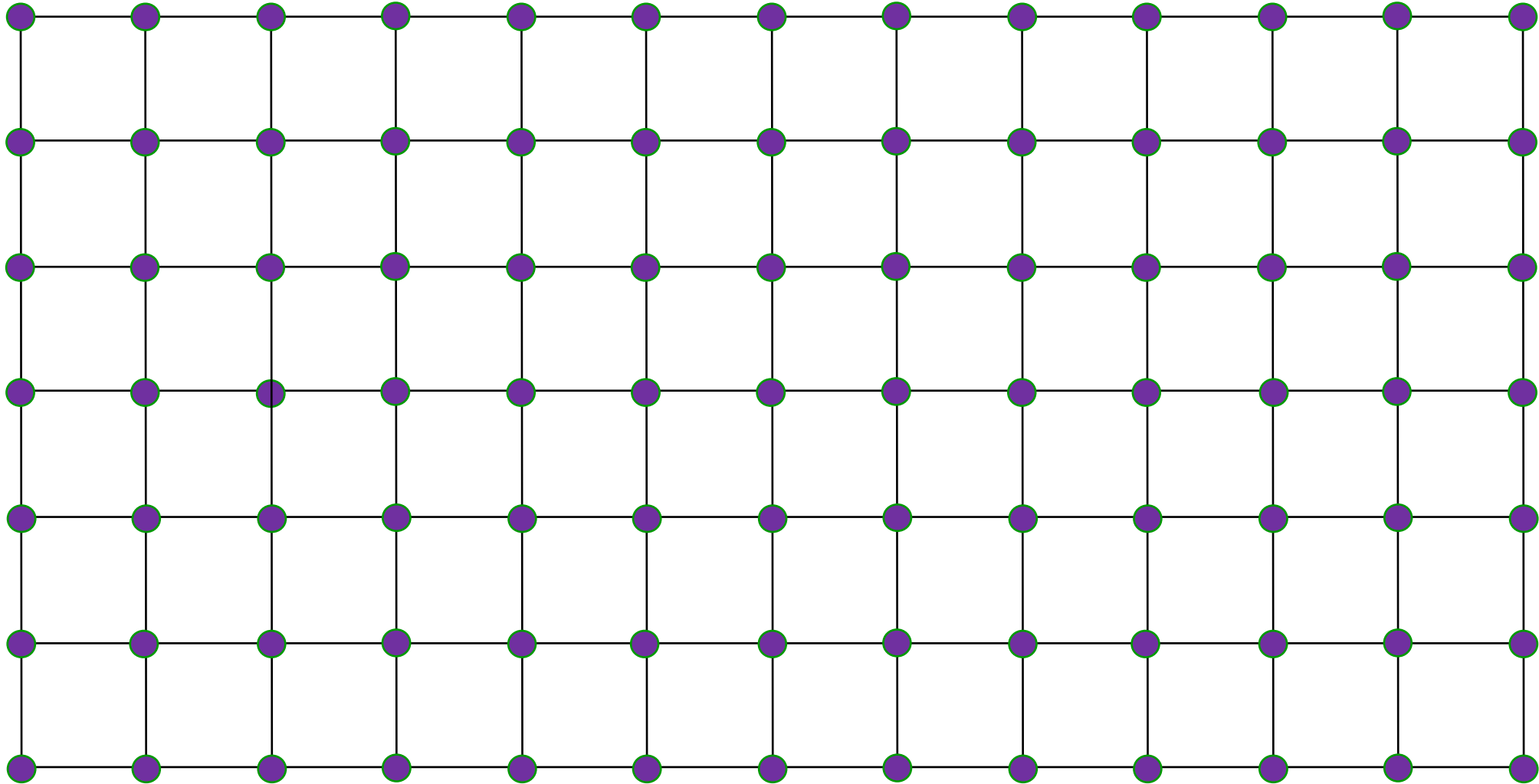

# 3D Crystal

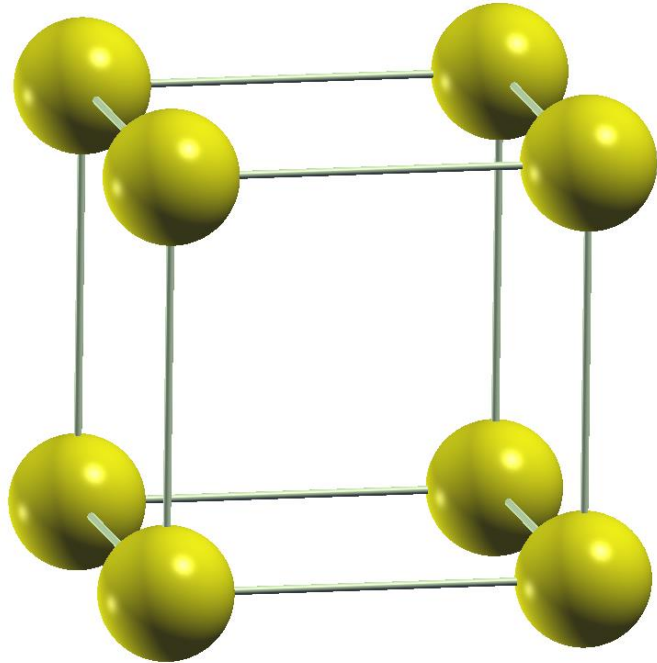

Simple cubic

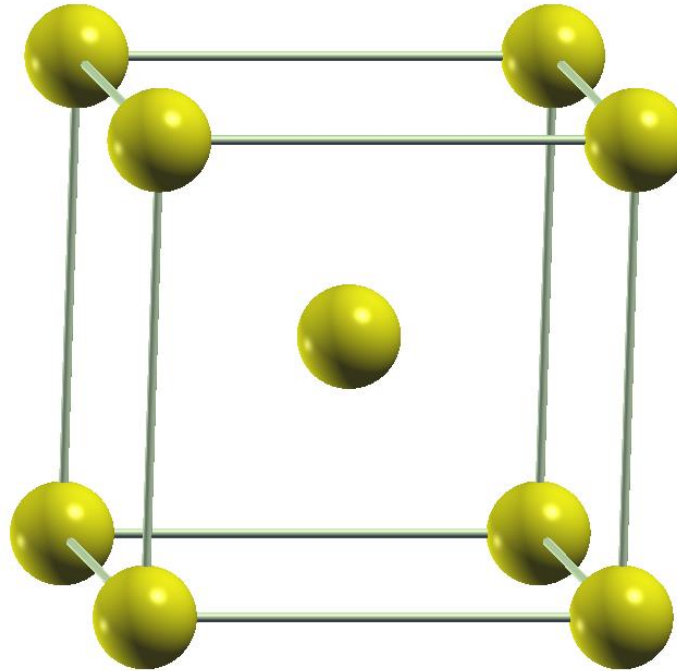

Body-centered cubic

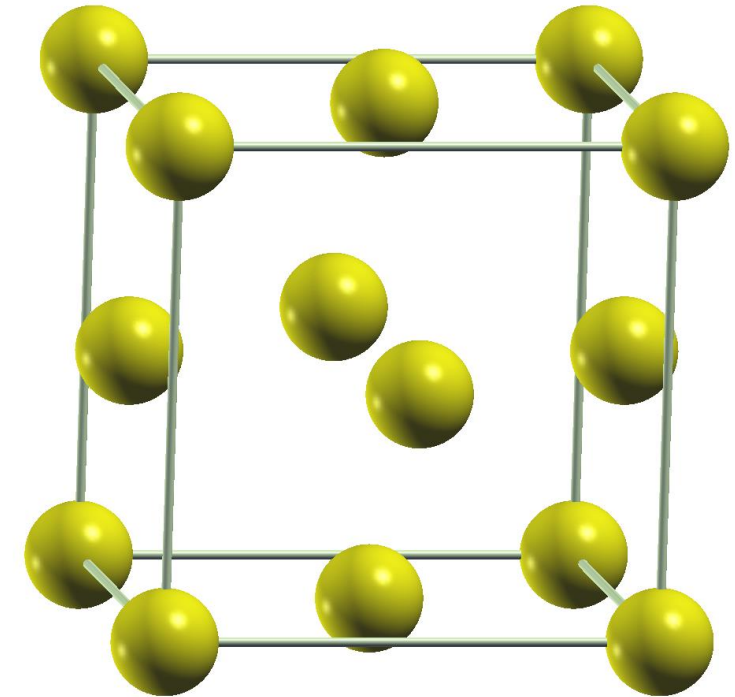

Face-centered cubic

# 3D Crystal

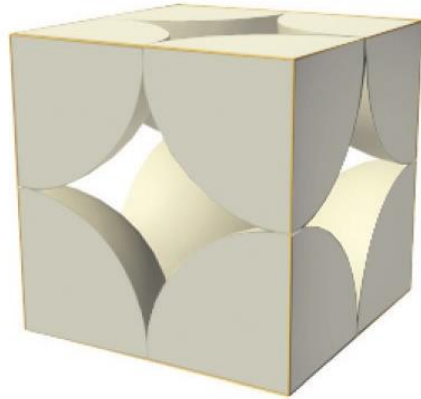

Simple cubic

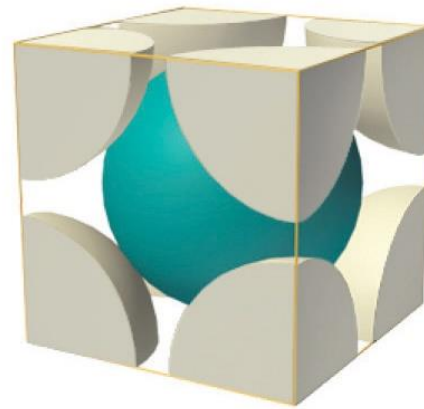

Body-centered cubic

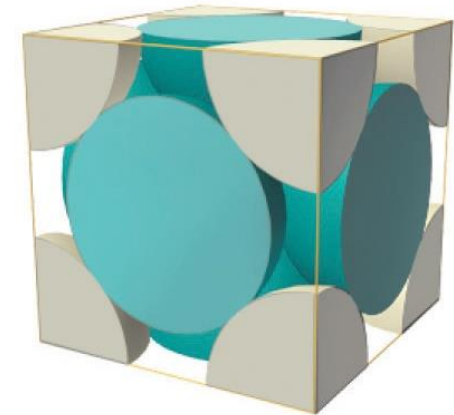

Face-centered cubic



# Particle Contributions to Unit Cell

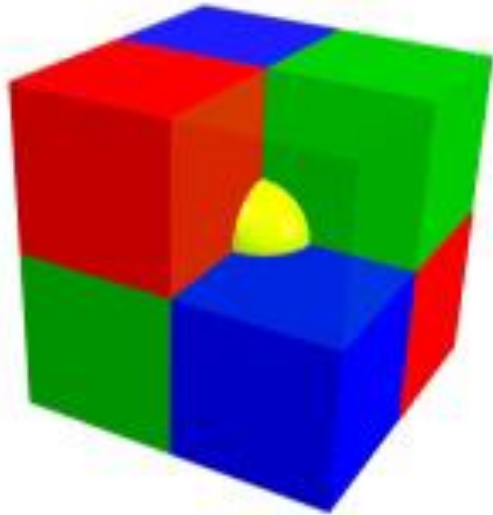

webassign.net



# Unit cell

## The Simplest Repeating Unit in a Crystal

The simplest repeating unit in a crystal is called a **unit cell**. Each unit cell is defined in terms of **lattice points**, the points in space about which the particles are free to vibrate in a crystal.



# Bravais lattice

A Bravais lattice, studied by Auguste Bravais (1850), is an infinite array of discrete points in three dimensional space generated by a set of discrete translation operations described by:

$$\vec{R} = n_1\vec{a}_1 + n_2\vec{a}_2 + n_3\vec{a}_3$$

Where  $n_i$  are any integers and  $\vec{a}_i$  are known as the primitive vectors which lie in different directions and span the lattice. This discrete set of vectors must be closed under vector addition and subtraction. For any choice of position vector  $\vec{R}$ , the lattice looks exactly the same.





# 2D Crystal

$$\vec{R} = n_1 \vec{a}_1 + n_2 \vec{a}_2$$

1	0
0	1
1	1
2	2

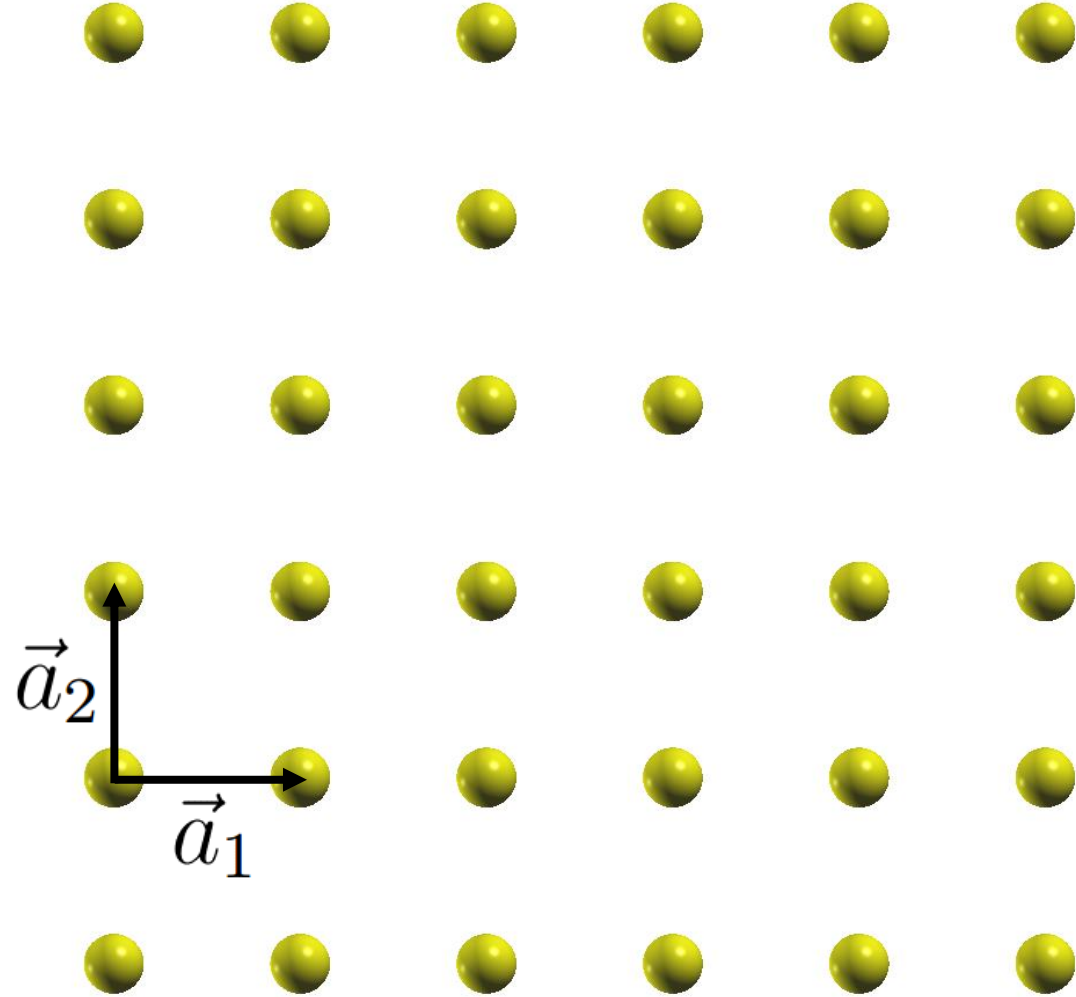

# 2D Crystal

$$\vec{R} = n_1 \vec{a}_1 + n_2 \vec{a}_2$$

1      0

0      1

-1     1

1      1

-2     2

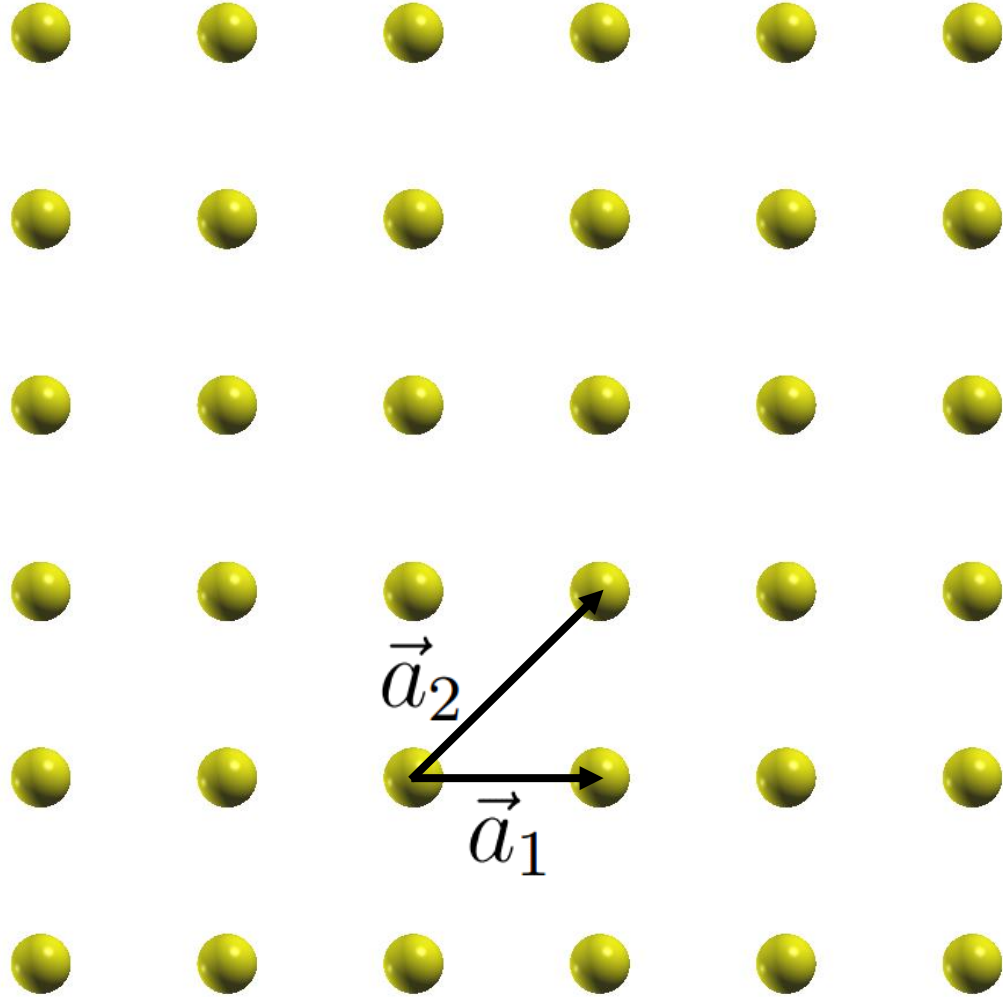

# Bravais lattice in 3D



Simple cubic

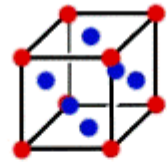

Face-centered cubic

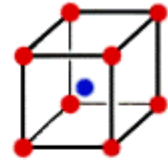

Body-centered cubic

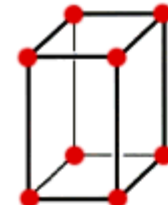

Simple orthorhombic

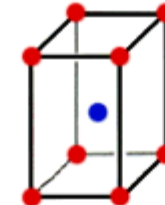

Body-centered orthorhombic

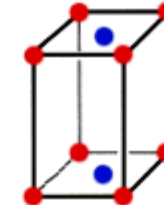

Base-centered orthorhombic

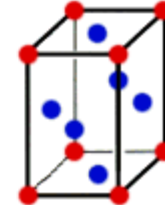

Face-centered orthorhombic

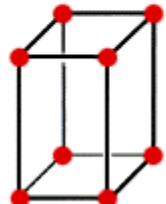

Simple tetragonal

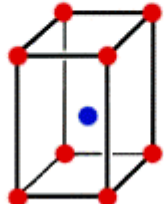

Body-centered tetragonal

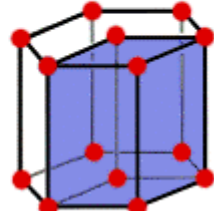

Hexagonal

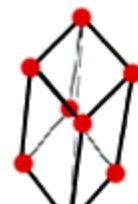

Rhombohedral

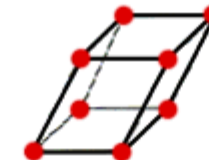

Simple Monoclinic

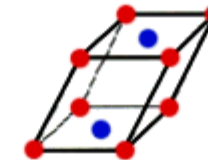

Base-centered monoclinic

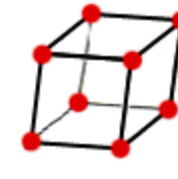

Triclinic

[epionelynx.wordpress.com](http://epionelynx.wordpress.com)



# Crystal structure

**basis + lattice = crystal structure**

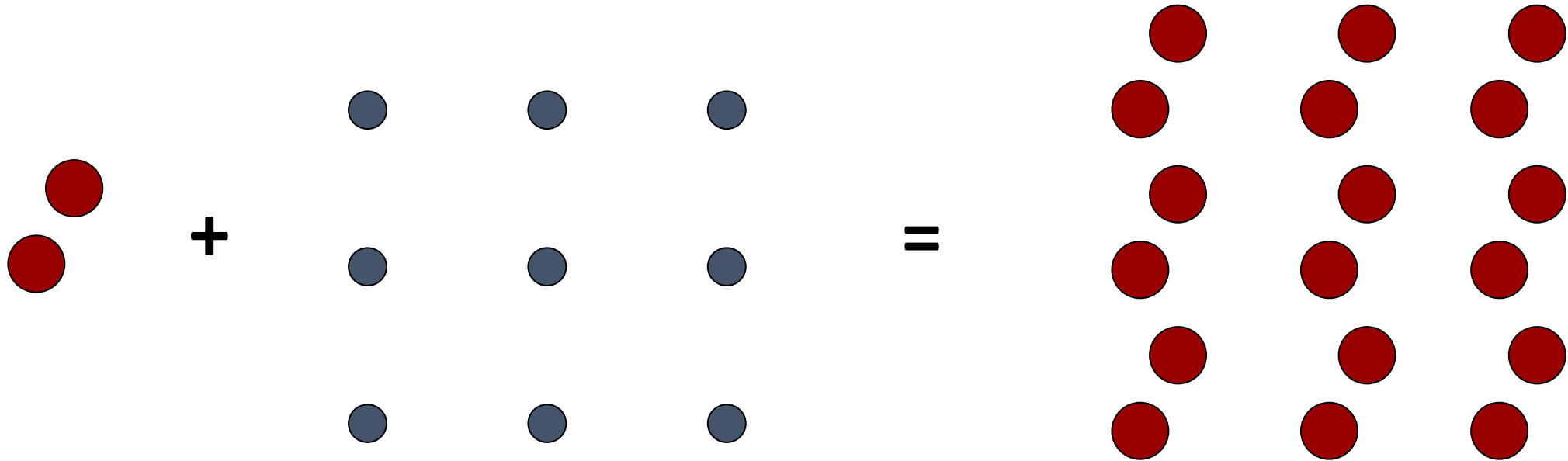

# Crystal structure

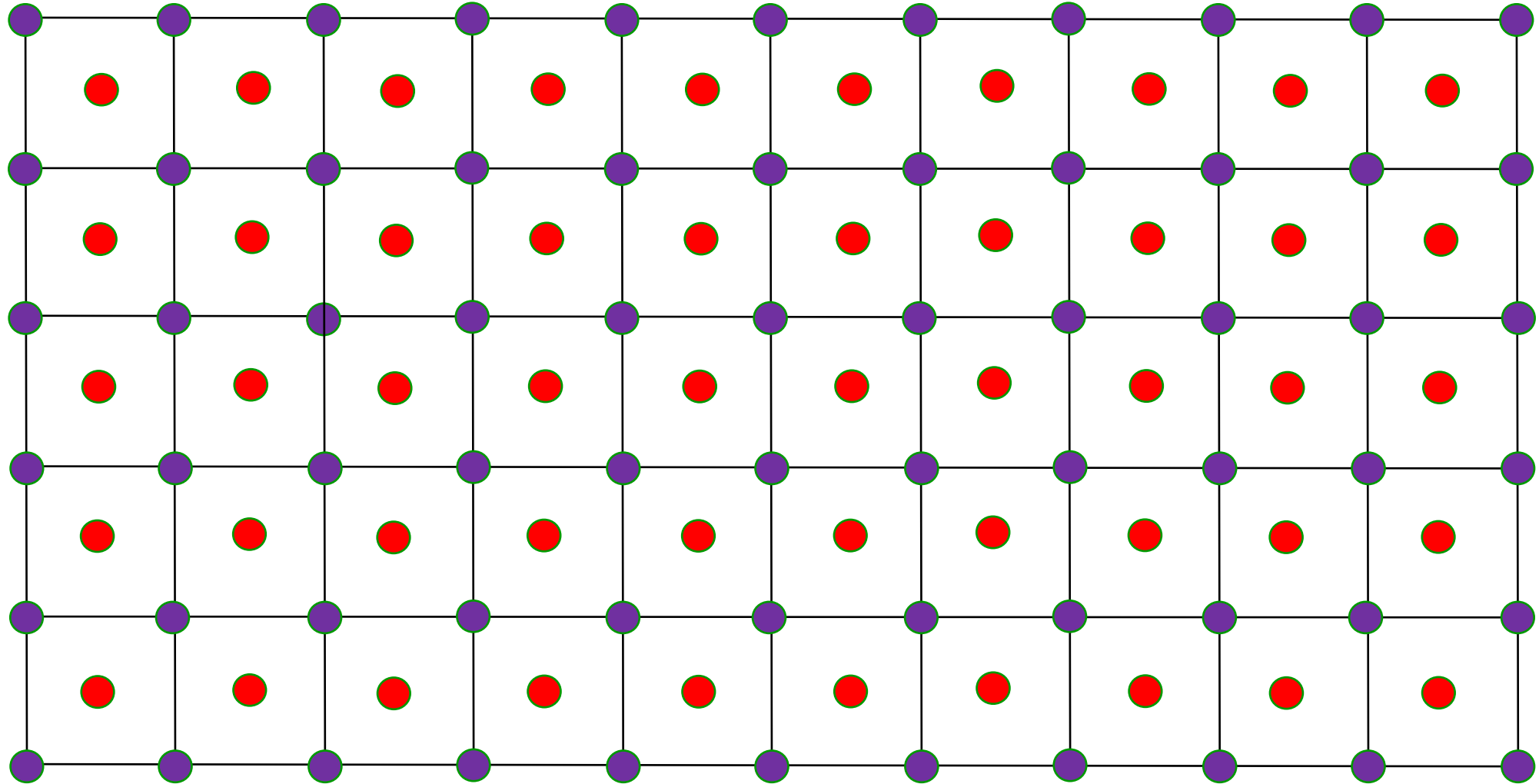

# Crystal structure

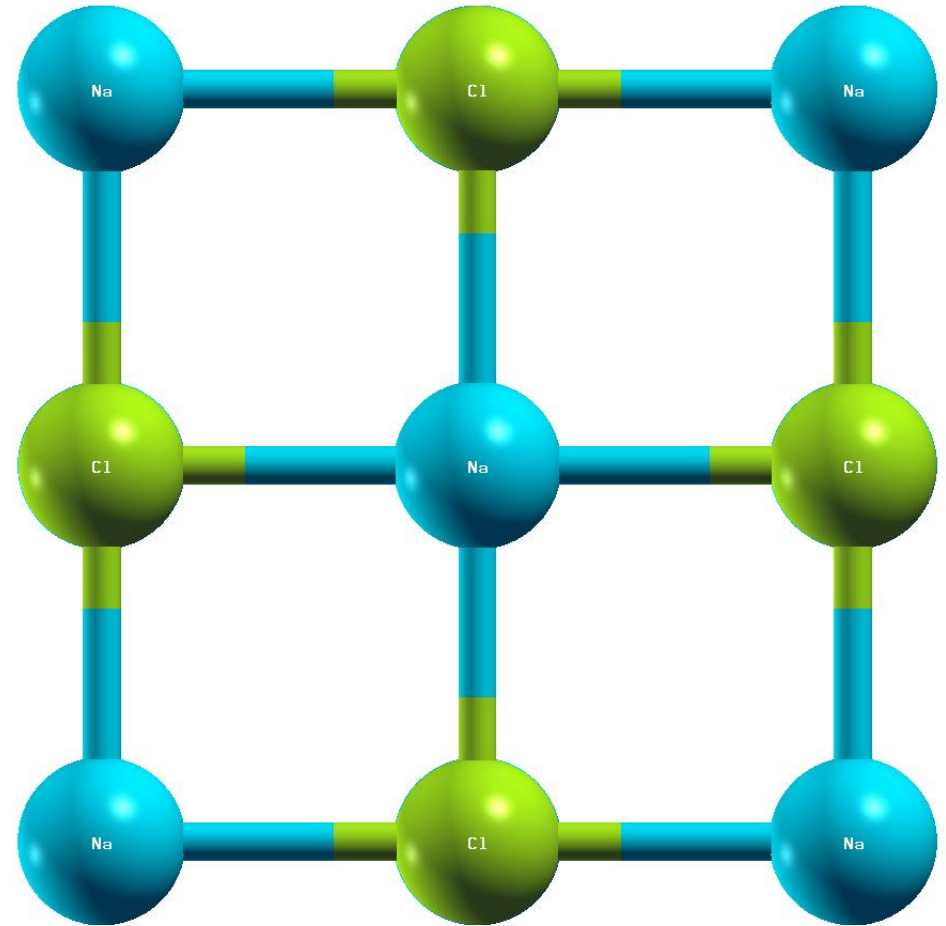
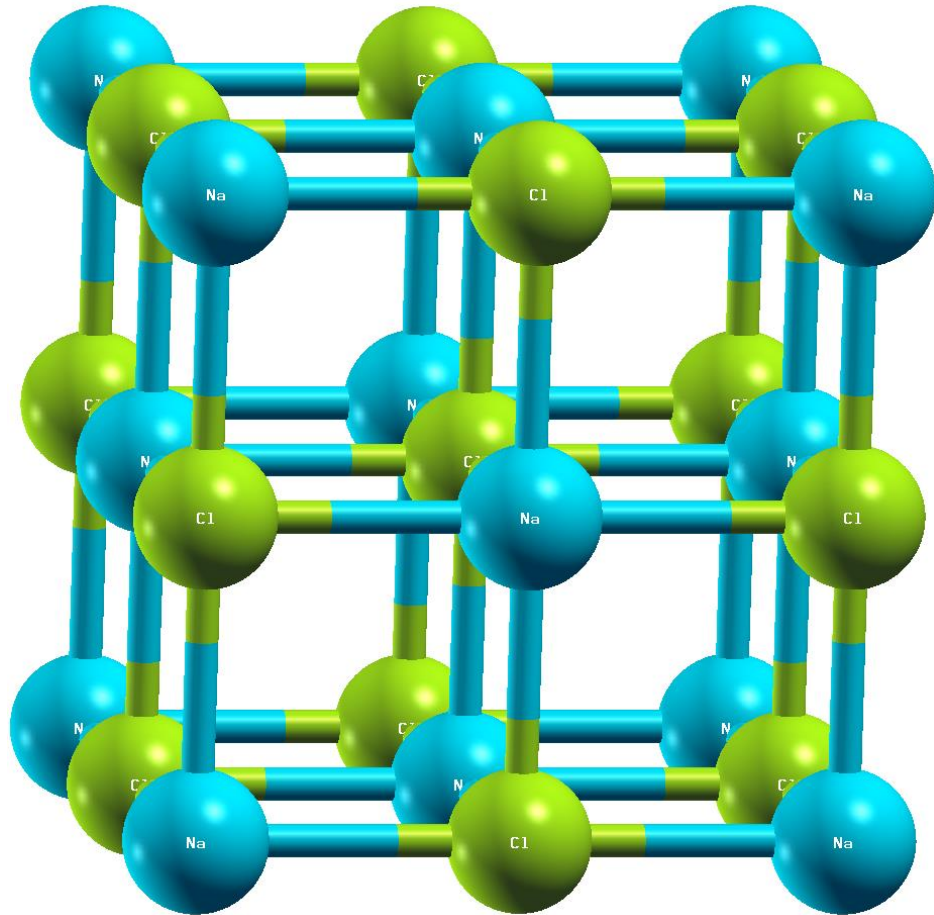



# Crystal structure

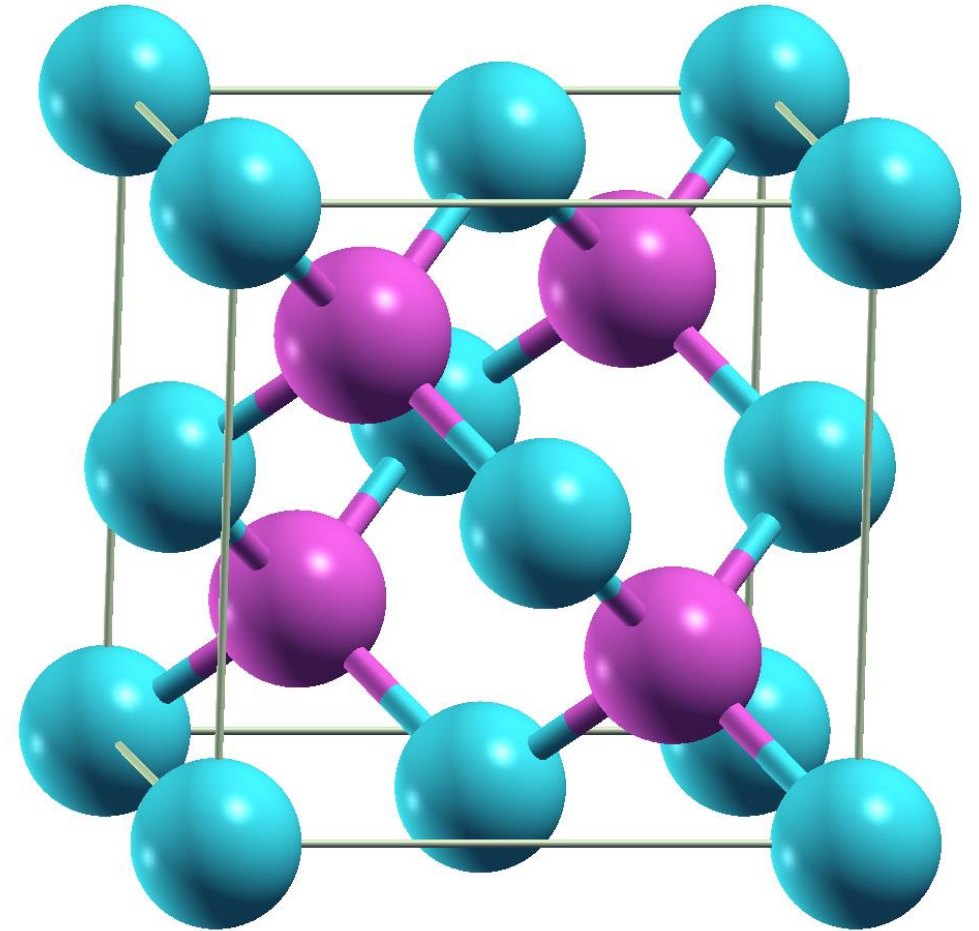
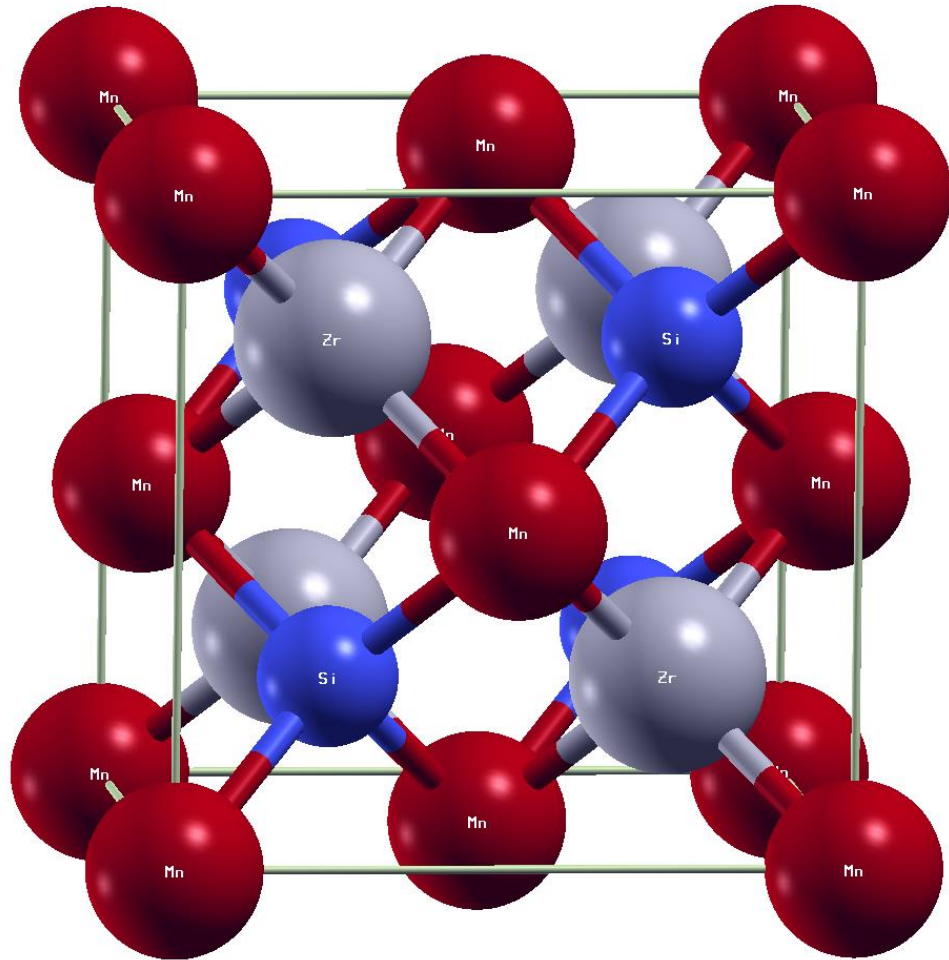

# Crystal structure

The lattice of  
crystalline  
quartz ( $\text{SiO}_2$ )

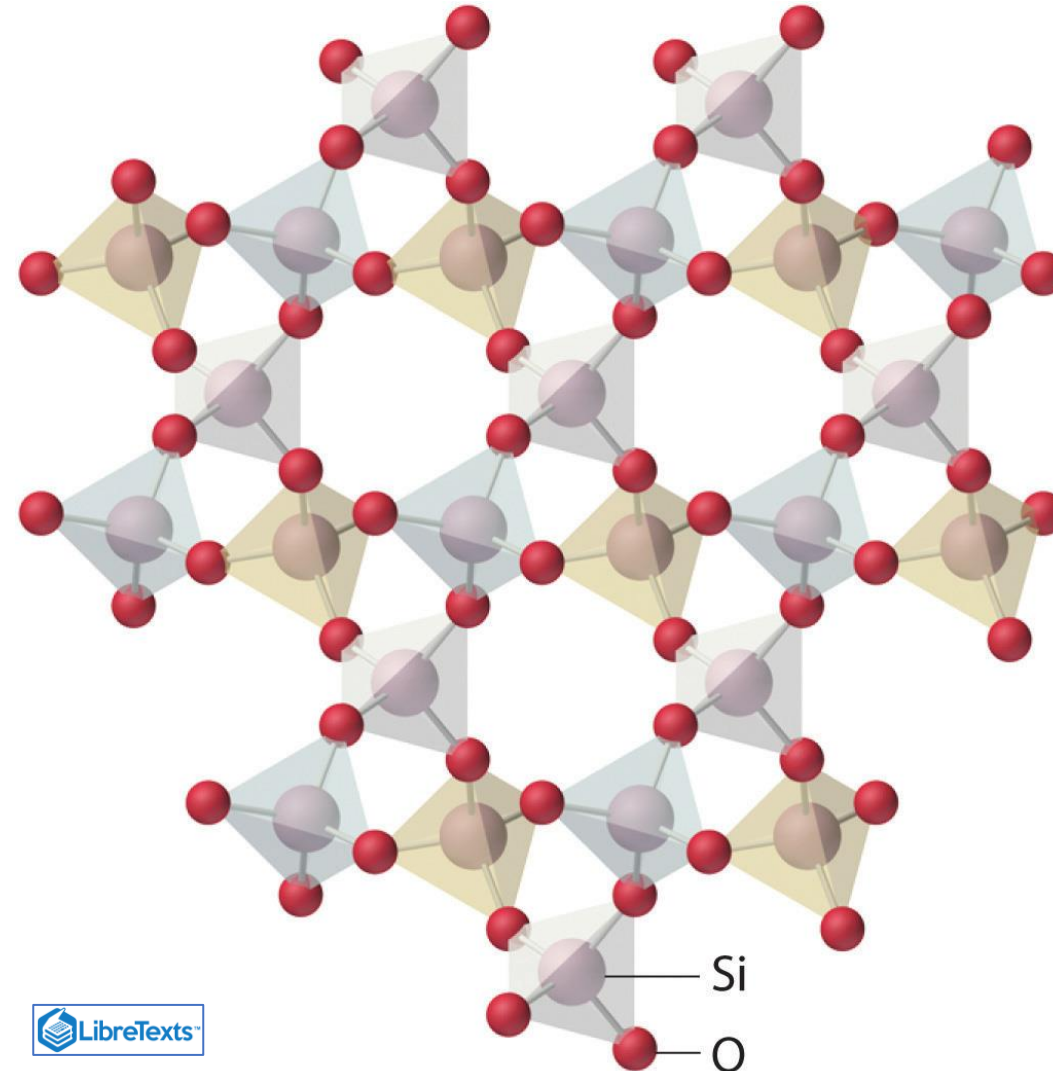

LibreTexts™





# Miller Indices

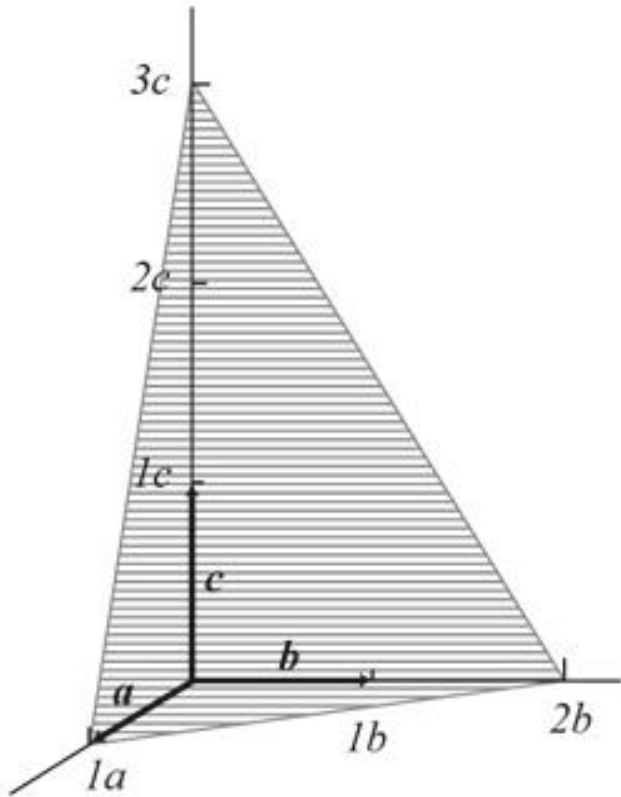

The Miller indices of a lattice plane are the coordinates of the shortest reciprocal lattice vector normal to the plane, with respect to a specific set of primitive reciprocal lattice vectors. Thus a plane with Miller indices  $(h \ k \ l)$ , is normal to the reciprocal lattice vector

$$h\vec{b}_1 + k\vec{b}_2 + l\vec{b}_3$$

Miller indices are used to specify directions and planes.

# The rules for Miller Indices:

- Determine the intercepts of the face along the crystallographic axes, *in terms of unit cell dimensions*.
- Take the reciprocals
- Clear fractions
- Reduce to lowest terms

$$(1, 2, 3) \rightarrow \left(\frac{1}{1} : \frac{1}{2} : \frac{1}{3}\right) \rightarrow (6 : 3 : 2) \rightarrow (632)$$

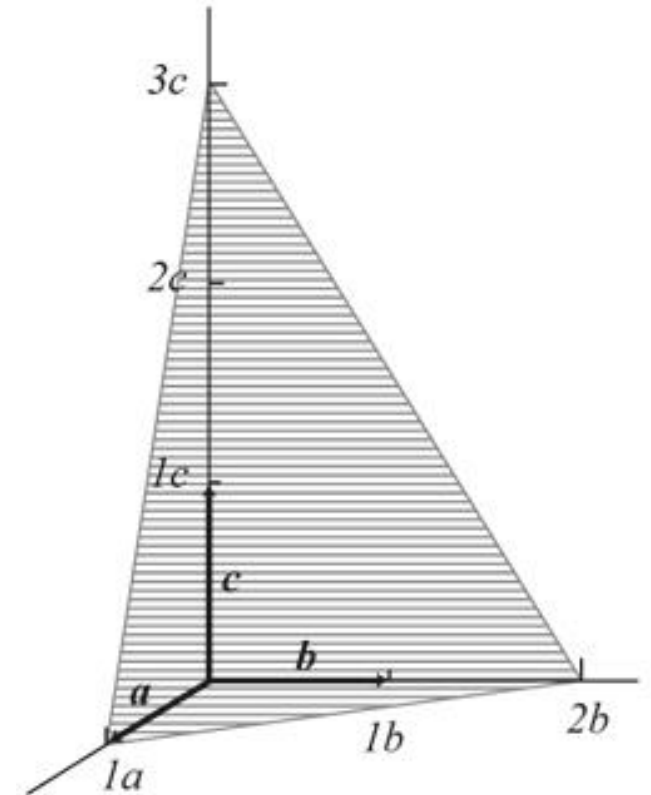

# Miller Indices

Miller Indices are the reciprocals of the parameters of each crystal face.

For Pink Face:  $\left(\frac{1}{1}, \frac{1}{\infty}, \frac{1}{\infty}\right) \rightarrow (100)$

For Green Face:  $\left(\frac{1}{\infty}, \frac{1}{\infty}, \frac{1}{1}\right) \rightarrow (001)$

For Yellow Face:  $\left(\frac{1}{\infty}, \frac{1}{1}, \frac{1}{\infty}\right) \rightarrow (010)$

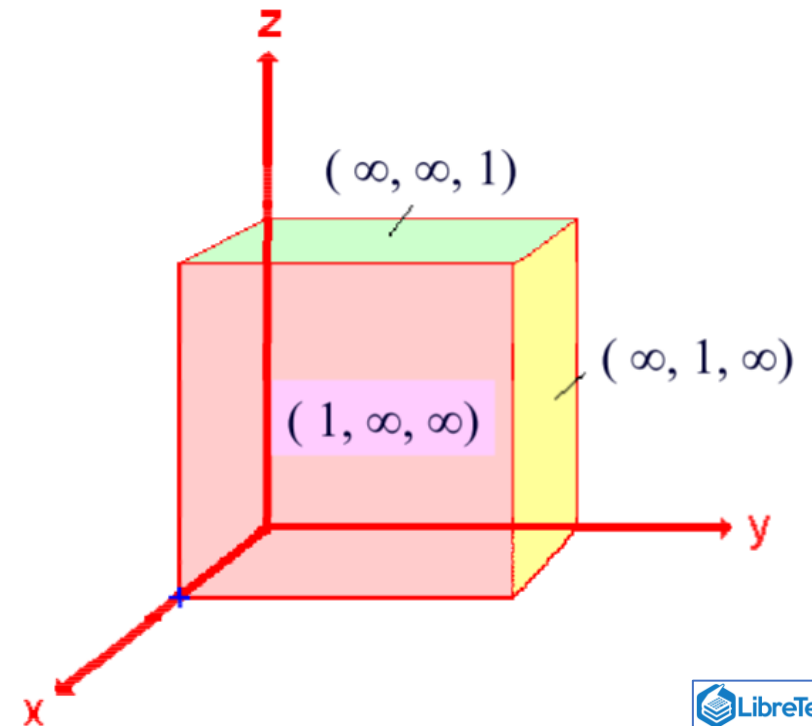

# Miller Indices

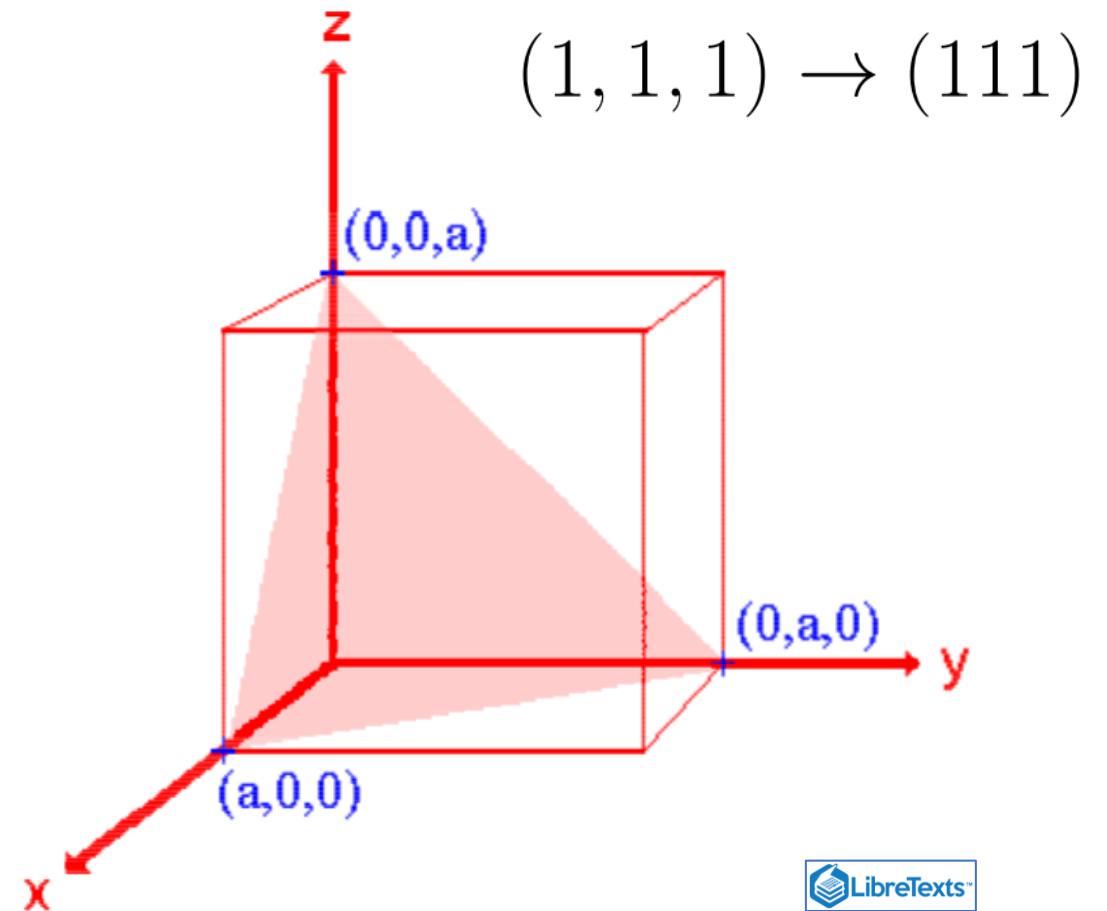
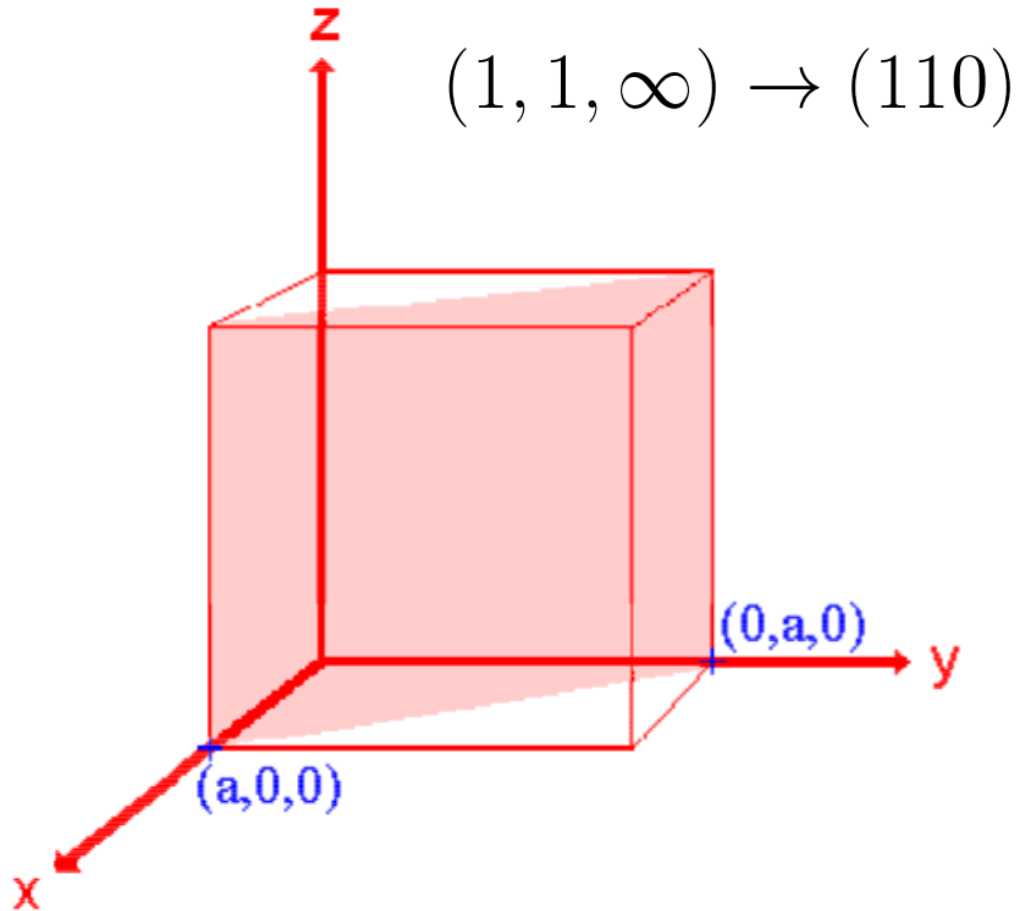

# Miller Indices

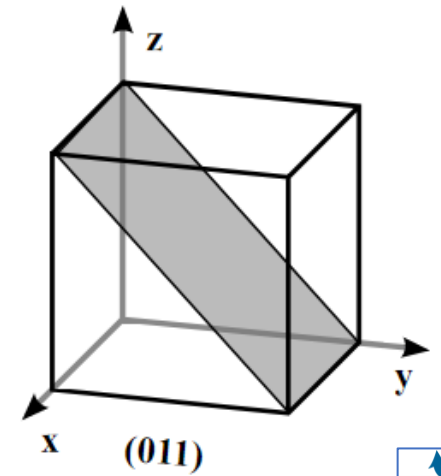
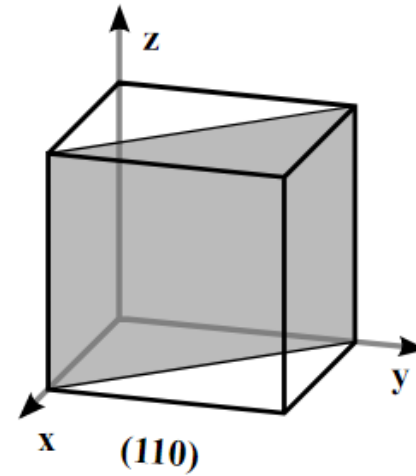
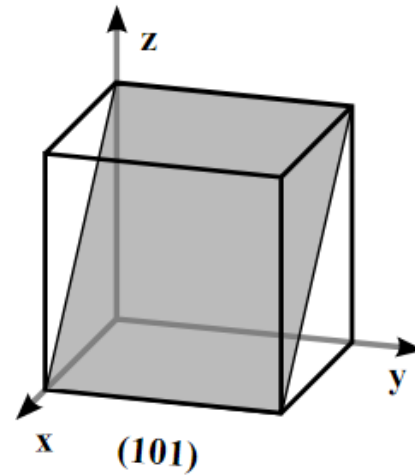
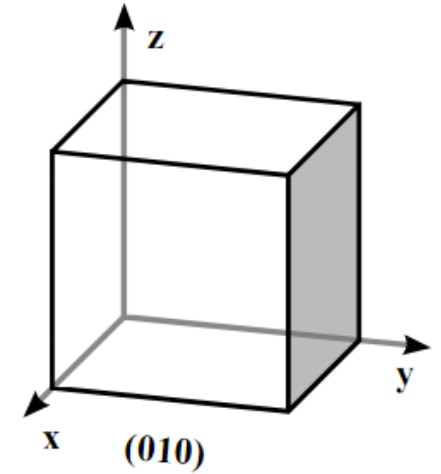
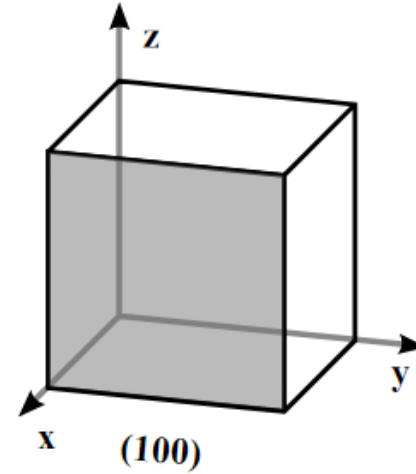
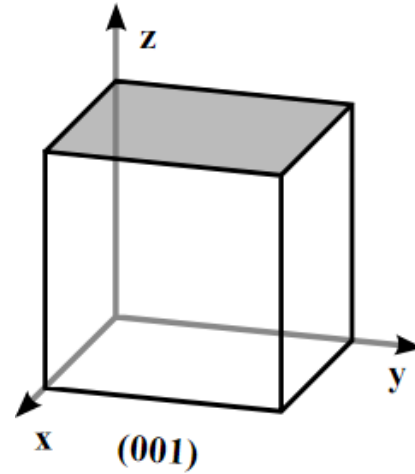
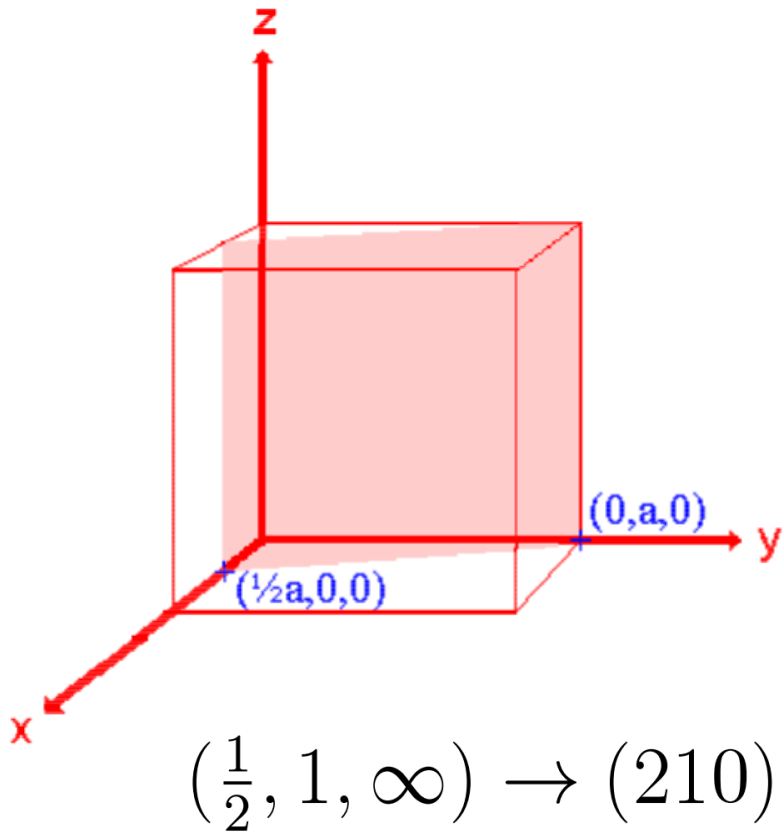

# Draw your own lattice planes

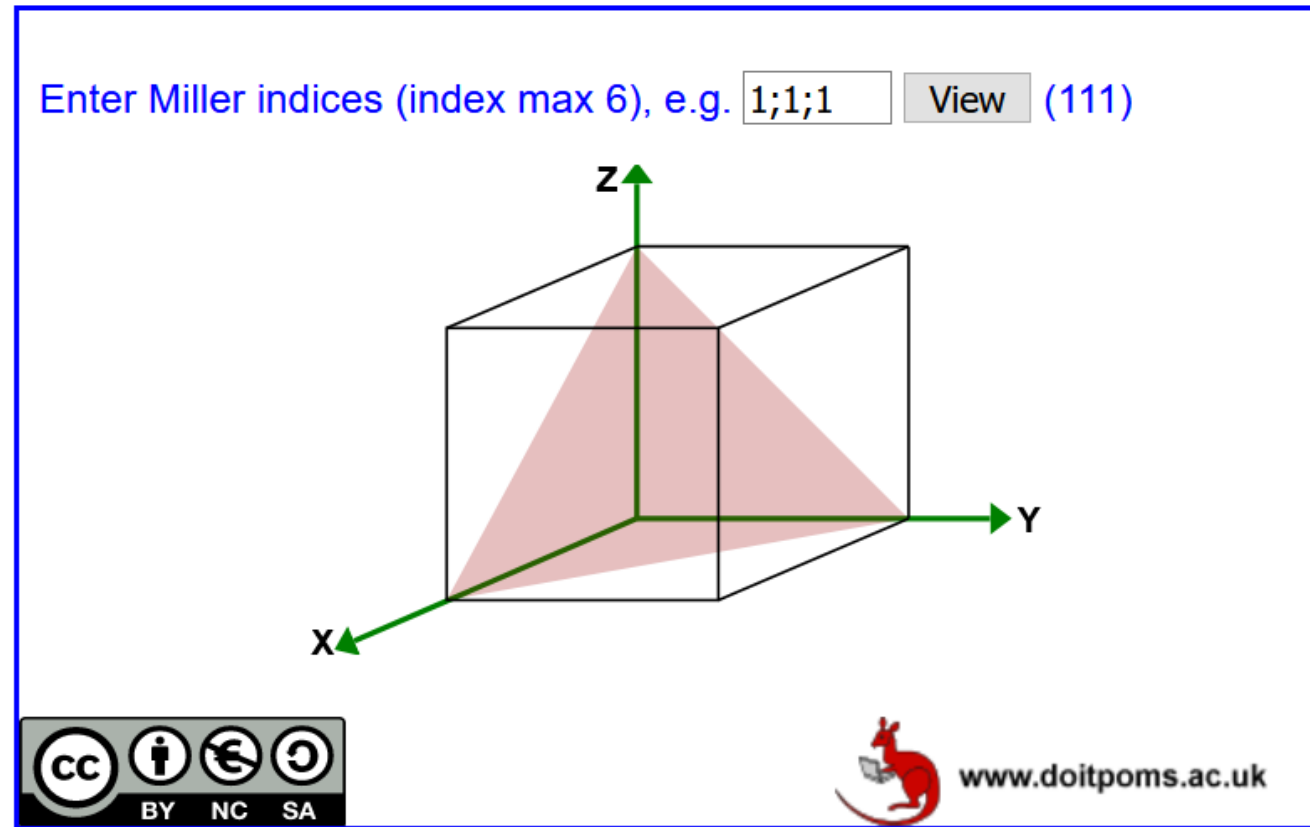

[https://www.doitpoms.ac.uk/tlplib/miller\\_indices/lattice\\_draw.php](https://www.doitpoms.ac.uk/tlplib/miller_indices/lattice_draw.php)

# Band Theory of Solids

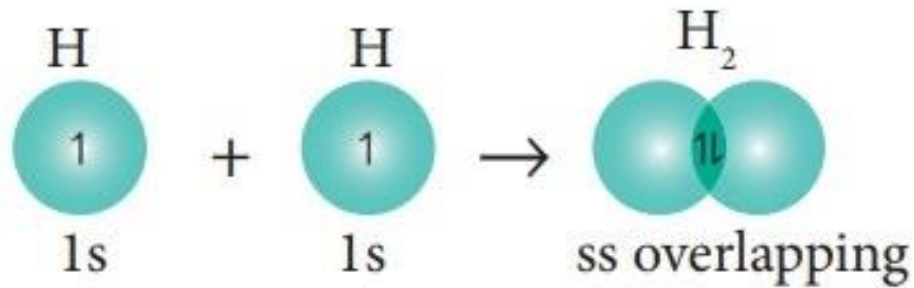

Formation of hydrogen molecule

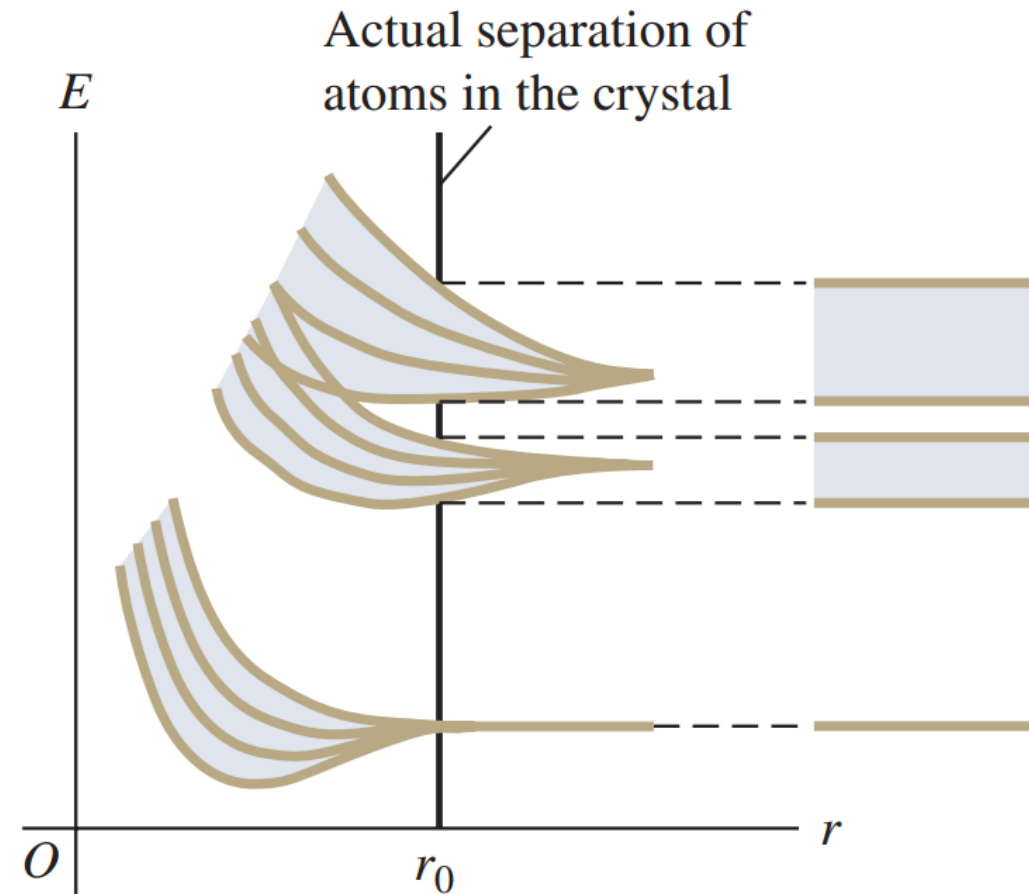

brainkart.com

University Physics– Young, Freedman



# Energy Bands for Solids

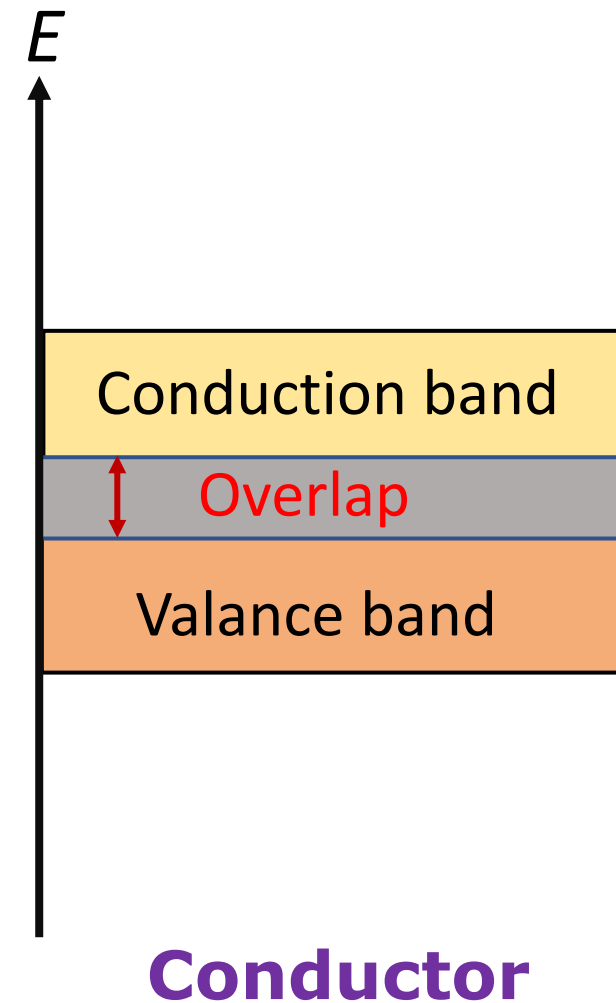
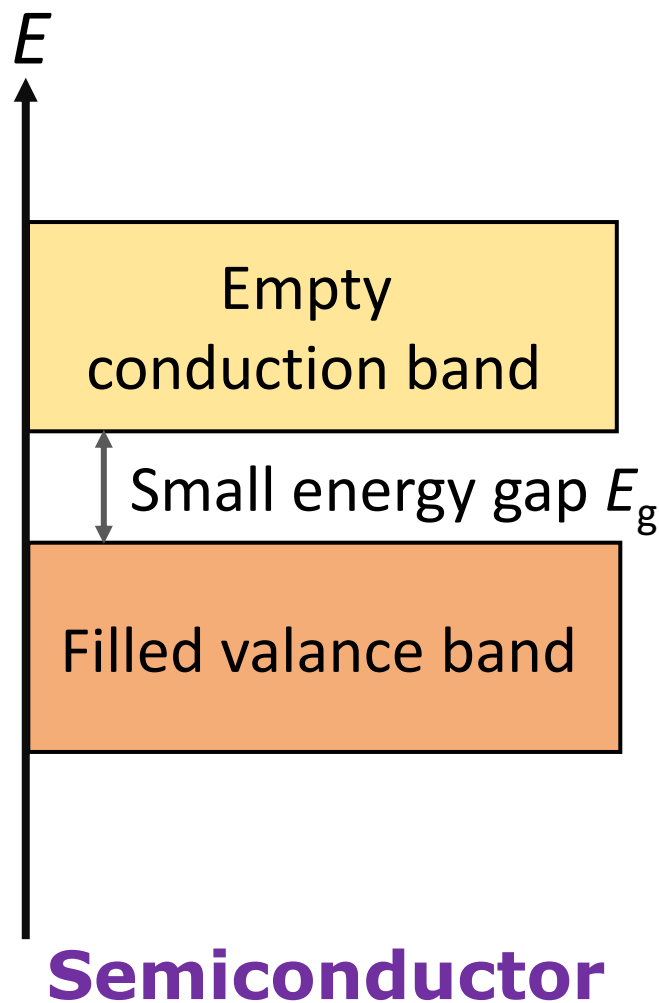
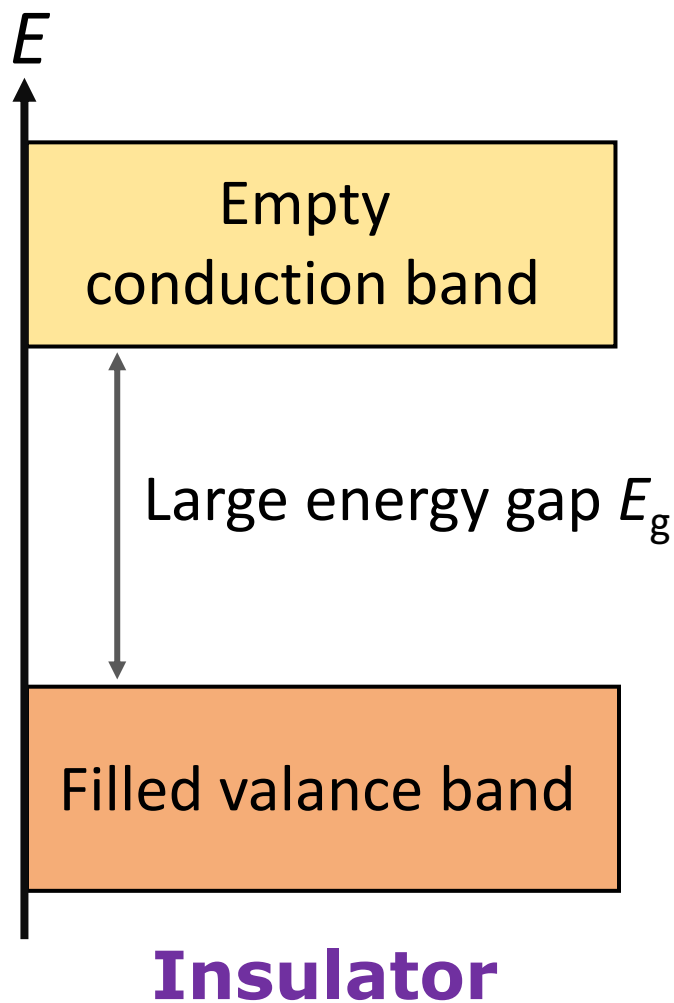



# Crystal Defects

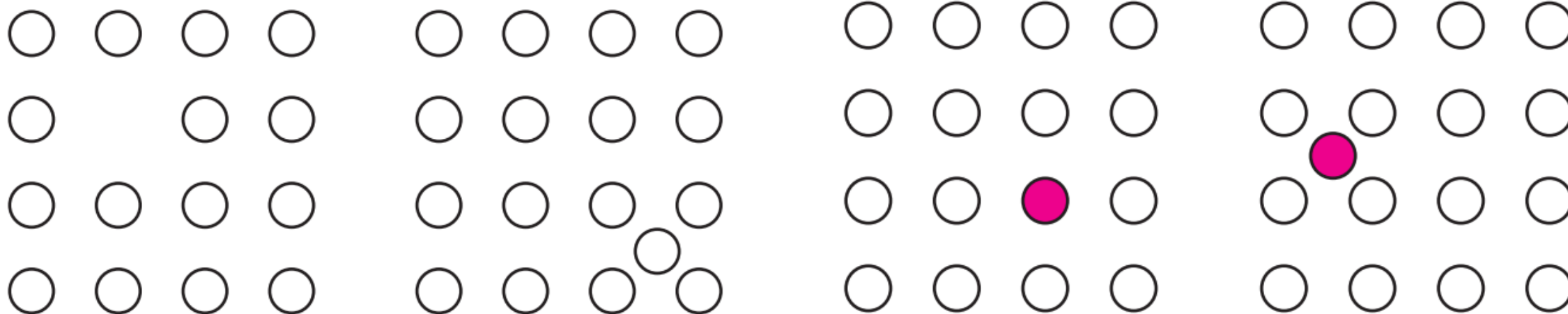

(a)

(b)

(c)

(d)

Point defects in a crystal. (a) Vacancy. (b) Interstitial.  
(c) Substitutional impurity. (d) Interstitial impurity.

*Concepts of Modern Physics – Arthur Beiser*



# Crystal Defects

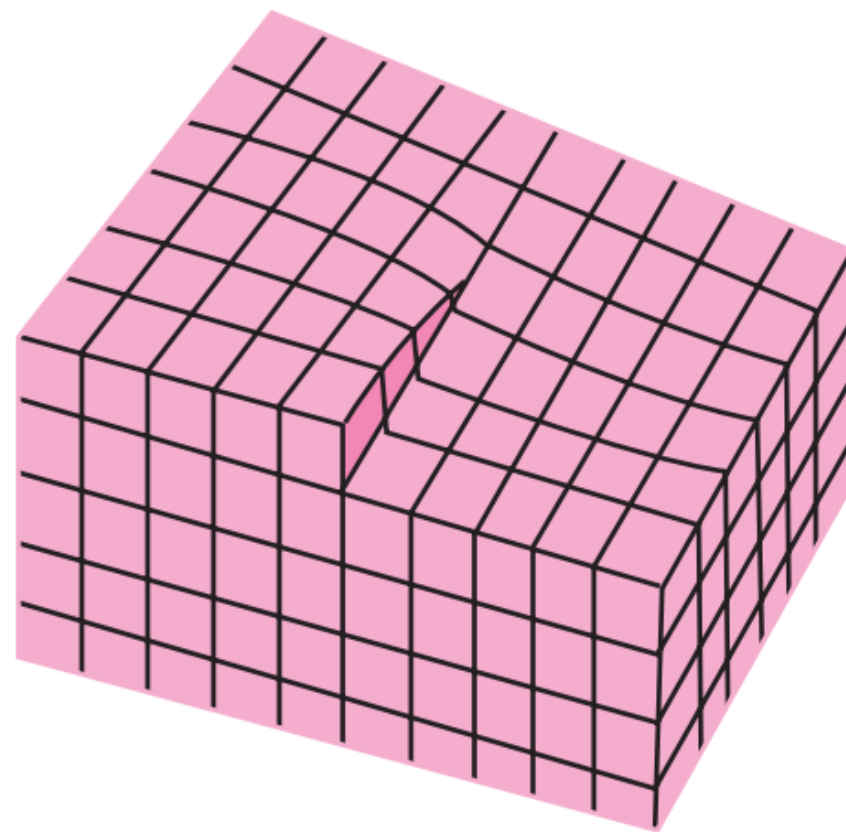
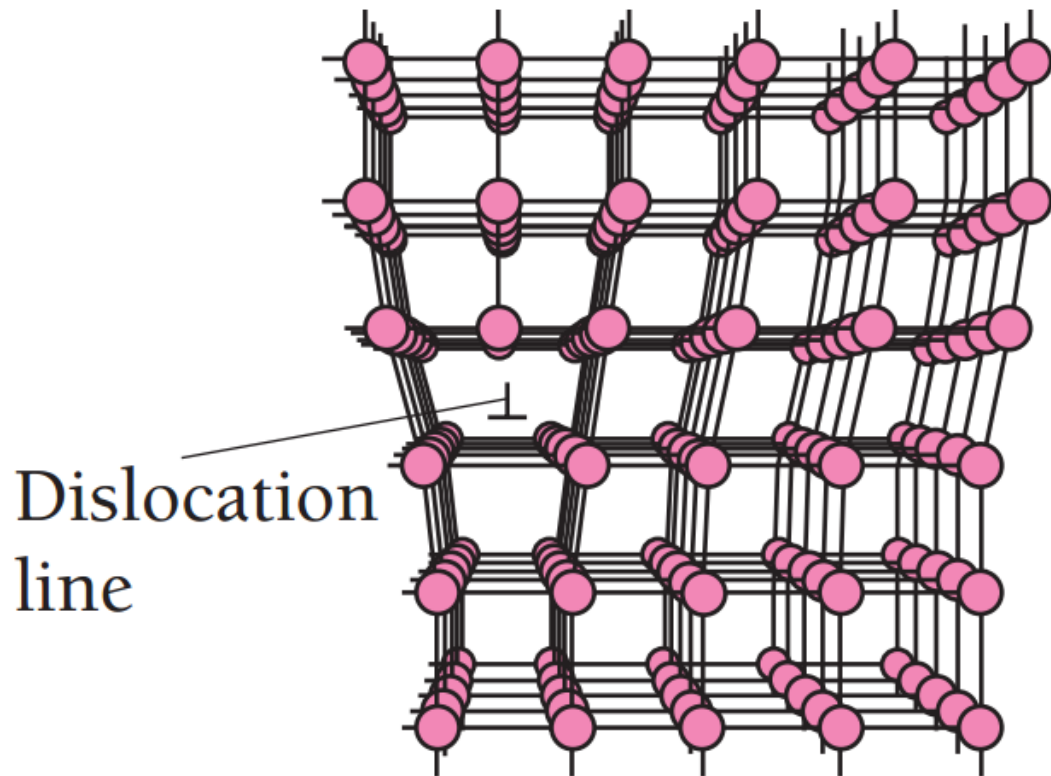

A screw dislocation.

*Concepts of Modern Physics – Arthur Beiser*



# Crystal Defects

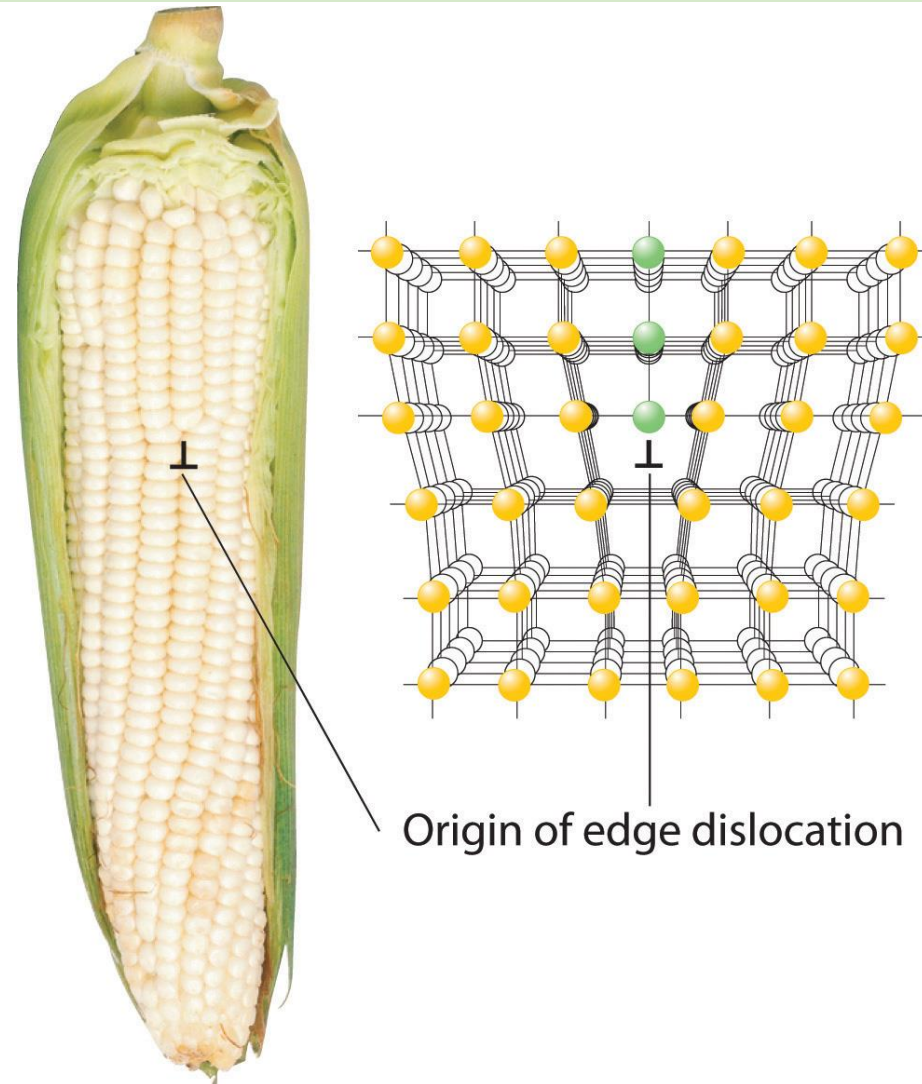

# Crystal Defects

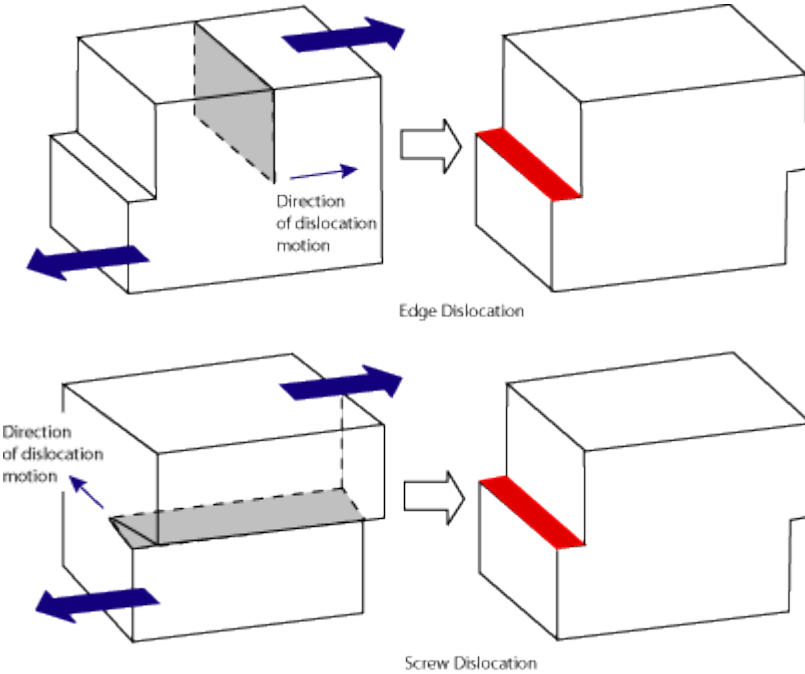
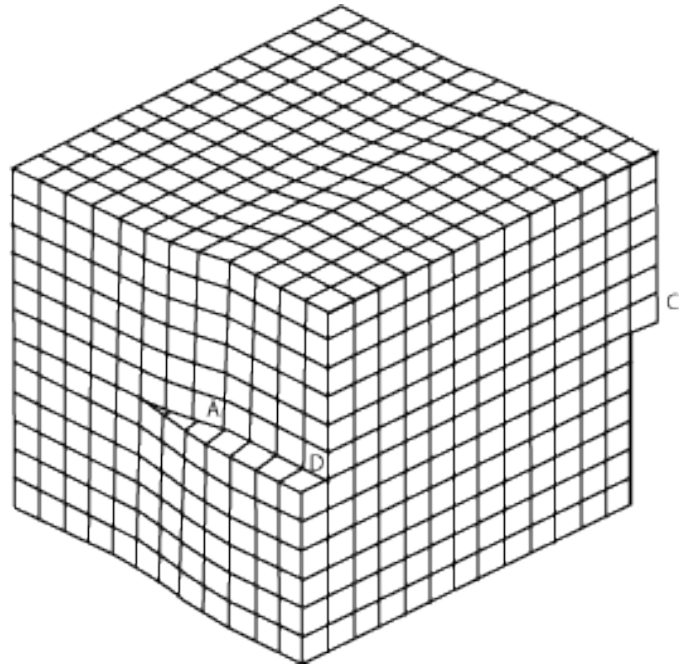

nde-ed.org

